

Dell PowerVault MD3860i Storage Arrays Owner's Manual

Regulatory Model: E08J Series
Regulatory Type: E08J001



Notes, Cautions, and Warnings

 **NOTE:** A NOTE indicates important information that helps you make better use of your computer.

 **CAUTION:** A CAUTION indicates either potential damage to hardware or loss of data and tells you how to avoid the problem.

 **WARNING:** A WARNING indicates a potential for property damage, personal injury, or death.

Copyright © 2015 Dell Inc. All rights reserved. This product is protected by U.S. and international copyright and intellectual property laws. Dell™ and the Dell logo are trademarks of Dell Inc. in the United States and/or other jurisdictions. All other marks and names mentioned herein may be trademarks of their respective companies.

2015 - 02

Rev. A01

Contents

1 About your system.....	6
Introduction.....	6
Dell PowerVault Modular Disk Storage Manager	6
Related Documentation.....	6
Front-Panel Features	7
Front-Panel Indicators	8
Back-Panel Features.....	10
Cooling Fan Module LED Indicator Codes.....	11
Power Supply Module Features And Indicators	12
Physical-Disk LED Indicators.....	13
2 Controller Modules.....	15
RAID Controller Modules.....	15
MD3860i iSCSI RAID Controller Module Features And Indicators.....	15
Expansion Controller Modules.....	16
MD3060e Expansion Module Features And Indicators.....	17
RAID Controller Module—Additional Features.....	18
Battery Backup Unit.....	18
Storage Array Thermal Shutdown.....	18
System Password Reset.....	18
3 Installing and removing system components.....	19
Recommended Tools.....	19
Removing And Installing The Front Bezel.....	19
Installing The Front Bezel.....	19
Removing The Front Bezel.....	20
Service Action Allowed Indicator LED.....	20
Physical-Disk Drawers.....	20
Opening The Physical-Disk Drawer.....	21
Closing The Physical-Disk Drawer.....	22
Removing The Physical-Disk Drawer.....	22
Installing The Physical-Disk Drawer.....	24
Physical Disks.....	25
Physical Disk Installation Guidelines.....	25
Removing A Physical Disk From A Physical-Disk Carrier.....	25
Installing A Physical Disk In A Physical-Disk Carrier.....	27
Removing A Physical Disk From A Physical-Disk Drawer.....	28
Installing A Physical Disk In A Physical-Disk Drawer.....	29

SAS Chain Cables.....	29
Removing The SAS Chain Cable(s).....	30
Installing The SAS Chain Cable(s).....	31
RAID Controller Modules.....	32
Removing A RAID Controller Module Or Expansion Module.....	32
Installing A RAID Controller Module Or Expansion Module.....	33
Opening The RAID Controller Module.....	34
Closing The RAID Controller Module.....	34
RAID Controller Module Backup Battery Unit.....	35
Removing The RAID Controller Module Backup Battery Unit.....	35
Installing The RAID Controller Module Backup Battery Unit.....	36
Power Supplies.....	36
Removing A Power Supply Module.....	36
Installing A Power Supply Module.....	37
Cooling Fan Modules.....	38
Removing A Cooling Fan Module.....	38
Installing A Cooling Fan Module.....	39
4 Troubleshooting your system.....	40
Safety first—for you and your system.....	40
Troubleshooting Storage Array Startup Failure.....	40
Troubleshooting Loss Of Communication.....	40
Troubleshooting External Connections.....	40
Troubleshooting Power Supply Modules.....	41
Troubleshooting Array Cooling Problems.....	41
Troubleshooting Expansion Enclosure Management Modules.....	42
If The EMM Status LED Is Solid Or Blinking Amber (2 Or 4 Times Per Sequence).....	42
If The Link Status LEDs Are Not Green.....	42
Troubleshooting Physical Disks.....	43
Troubleshooting Array And Expansion Enclosure Connections.....	43
Troubleshooting A Wet Storage Array.....	44
Troubleshooting A Damaged Array.....	44
Controller Failure Conditions.....	44
Critical Conditions.....	45
Noncritical Conditions.....	45
Invalid Storage Array.....	45
ECC Errors.....	45
PCI Errors.....	46
5 Technical Specifications.....	47
6 Getting help.....	50

Locating your system service tag.....	50
Contacting Dell.....	50
Documentation feedback.....	50

About your system

Introduction

 **CAUTION:** See the **Safety, Environmental, and Regulatory Information** document for important safety information before following any procedures listed in this document.

The Dell PowerVault MD3860i RAID storage array (10 Gbps iSCSI) is a 4U rack-mounted system, capable of accommodating up to sixty 3.5 inch or 2.5 inch physical disks. You can expand the number of physical disks up to a maximum of 120 disks (180 disks with premium feature kit), by daisy-chaining your storage enclosure with up to two MD3060e SAS based expansion enclosures.

 **NOTE:** Your Dell MD Series Dense storage array supports two expansion enclosures (180 physical disks) after you install the **Additional Physical Disk Support Premium Feature**. To order the **Additional Physical Disk Support Premium Feature** key, go to dell.com/support.

This document familiarizes you with the functions of the Dell PowerVault MD Series storage array. The document is organized according to the tasks that you must complete after receiving your storage array.

Dell PowerVault Modular Disk Storage Manager

Dell PowerVault Modular Disk Storage Manager (MD Storage Manager) is a graphical user interface (GUI) application used to configure and manage one or more MD Series storage arrays. The MD Storage Manager software is located on the MD Series resource DVD.

Related Documentation

 **WARNING:** See the safety and regulatory information that shipped with your system. Warranty information may be included within this document or as a separate document.

 **NOTE:** For all PowerVault documentation, go to dell.com/powervaultmanuals and enter the system Service Tag to get your system documentation.

 **NOTE:** For all Dell OpenManage documents, go to dell.com/openmanagemanuals.

 **NOTE:** For all storage controller documents, go to dell.com/storagecontrollermanuals.

- *Dell PowerVault MD3460/3860i/3860f Series Storage Arrays Getting Started Guide* — Provides an overview of system features, setting up your system, and technical specifications. This document is also shipped with your system.
- *Dell PowerVault MD3860i Series Storage Arrays Owner's Manual* — Provides information about system features and describes how to troubleshoot the system and install or replace system components.
- *Rack Installation Instructions* — Describes how to install your system into a rack. This document is also shipped with your rack solution.

- *Dell PowerVault MD Series Storage Arrays Administrator's Guide* — Provides information about configuring and managing the system using the MDSM GUI.
- *Dell PowerVault MD Series Storage Arrays CLI Guide* — Provides information about configuring and managing the system using the MDSM CLI.
- *Dell PowerVault MD3860i Series Storage Arrays Deployment Guide* — Provides information about deploying the storage system in the SAN architecture.
- *Dell PowerVault MD 34xx and 38xx Series Support Matrix* — Provides information about the software and hardware compatibility matrices for the storage array.
- For the full name of an abbreviation or acronym used in this document, see the Glossary at dell.com/support/manuals.
- For Online Help Resource, navigate to dell.com/PVResources.

 **NOTE:** For the latest documentation updates, check dell.com/support/manuals.

 **NOTE:** When upgrading your system, it is recommended that you download and install the latest BIOS, driver, and systems management firmware on your system from dell.com/support.

Front-Panel Features

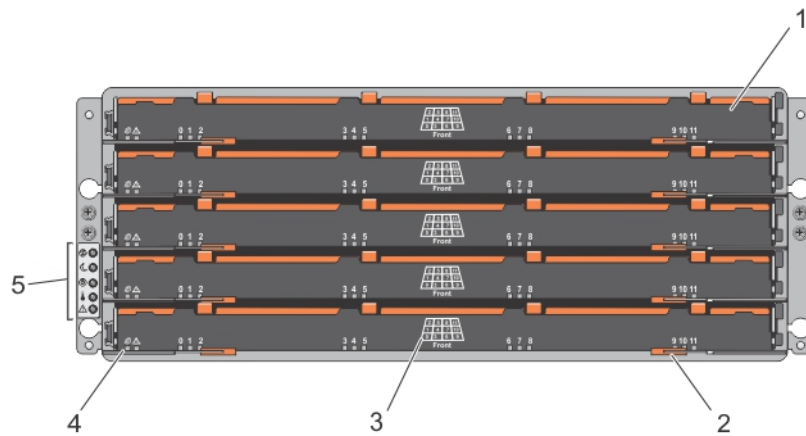

Figure 1. Front-Panel Features

- | | |
|---------------------------------|--|
| 1. drawer (5) | 2. drawer release latch (2 per drawer) |
| 3. physical disk slot numbering | 4. drawer indicator LEDs |
| 5. front-panel indicators | |

Front-Panel Indicators

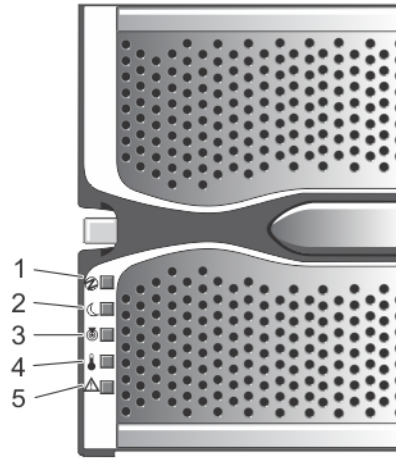

Figure 2. Front-Bezel Indicators

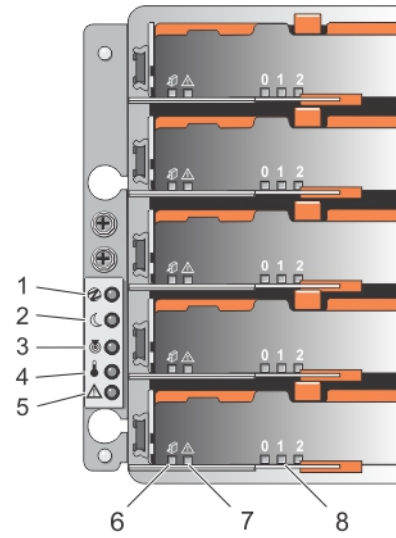













Figure 3. Front-Panel Indicators

Item	Indicator	Icon	Description
1	Power-on indicator		The power-on indicator lights green when at least one power supply module is supplying power to the storage enclosure.
2	Standby power indicator		The standby power indicator lights green when the system is in standby mode and the main power is off.
3	System identification indicator		The system identification indicator lights white and helps locate a particular enclosure within a rack.
4	Over temperature indicator		The over temperature indicator lights amber when the temperature of the system has reached an unsafe condition.
5	Service action required indicator (system)		The Service action required indicator lights amber when there is a fault in one of the components in the system.
6	Service action allowed indicator (system)		<p> CAUTION: Remove the physical disk drawer from the system only if the Service action allowed indicator lights blue. Removing the physical disk drawer from the system when the Service action allowed indicator is off may damage the system.</p> <p> NOTE: The Service action allowed indicator LED is not used in server attached configurations.</p> <p>Blue Indicates that you can safely remove the physical disk drawer from the system.</p> <p>Off Indicates that you cannot remove the physical disk drawer from the system.</p>
7	Service action required indicator (drawer)		<p>Amber Indicates that the cable is attached and at least one lane has a link up status, but at least one lane has a link down status.</p> <p>Off Indicates that:</p> <ul style="list-style-type: none"> • No cable is attached. • A cable is attached, and all lanes have a link up status. • A cable is attached, and all lanes have a link down status.

Item	Indicator	Icon	Description
8	Drive activity indicator		<p>NOTE: The associated physical disk is indicated by a number (0 to 11) that is displayed above the drive activity indicator. For example, for physical disk 2 on the physical disk drawer, the drive activity indicator has 2 displayed above the drive activity indicator.</p> <p>Green Indicates that power is on and the physical disk is operating normally.</p> <p>Blinks green Indicates I/O activity for that physical disk.</p> <p>Off Indicates that there is no power reaching the drive or a drive is not installed.</p>

Back-Panel Features

 **NOTE:** The following illustration displays the Dell PowerVault MD3860i storage enclosure.

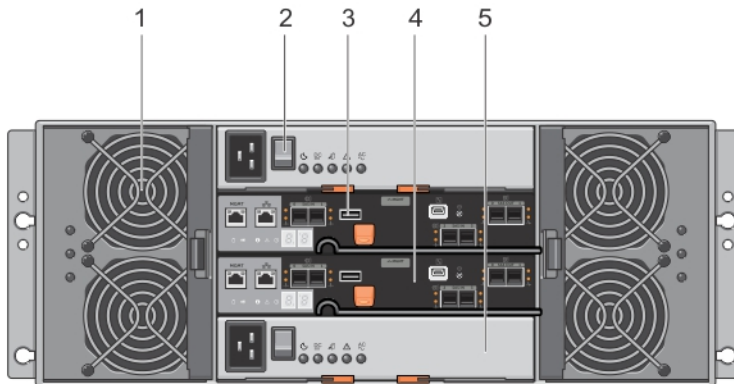

Figure 4. Back-Panel Features

- | | |
|----------------------------|-------------------------------|
| 1. cooling fan module (2) | 2. power supply switch (2) |
| 3. USB port | 4. raid controller module (2) |
| 5. power supply module (2) | |

Cooling Fan Module LED Indicator Codes

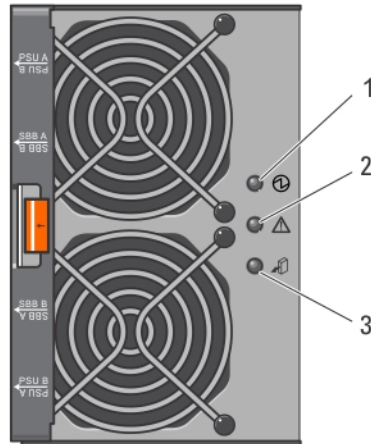

Figure 5. Cooling Fan Module Indicators

Item	Indicator	Icon	Description
1	Power indicator		The power indicator lights green when power to the cooling fan module is available.
2	Service action required indicator		The Service action required indicator lights amber when there is a fault in the cooling fan module.
3	Service action allowed indicator		<p>CAUTION: Remove the cooling fan module from the system only if the Service action allowed indicator lights blue. Removing the cooling fan module from the system when the Service action allowed indicator is off may damage the system.</p> <p>NOTE: The Service action allowed indicator LED is not used in server attached configurations.</p> <p>Blue Indicates that you can safely remove the cooling fan module from the system.</p> <p>Off Indicates that you cannot remove the cooling fan module from the system.</p>

Power Supply Module Features And Indicators

NOTE: Your storage array is shipped with two IEC C19 to C20 jumper cords. Connect the C19 plug to the array's power supplies and the C20 plug to the power distribution unit (PDU) in the rack cabinet.

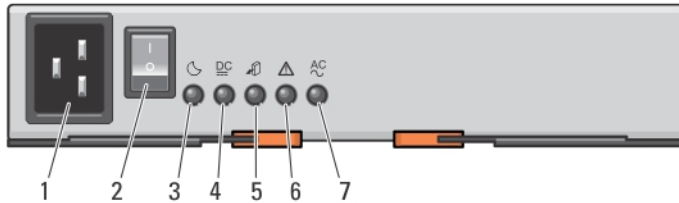



Figure 6. Power Supply Module Features and Status Indicators

Item	Indicator or Connector	Icon	Description
1	Power connector		Connect the external power supply source to this connector.
2	Power switch		The power switch controls the power supply output to the system.
3	Standby power indicator		The standby power indicator lights green when the system is in standby mode and the main power is off.
4	DC power indicator		Green Indicates that DC output voltage is within the limit.
			Off Indicates that DC output voltage is not within the limit.
5	Service action allowed indicator		CAUTION: Remove the power supply module from the system only if the service action allowed indicator lights blue. Removing the power supply module from the system when the service action allowed indicator is off may damage the system.
			Blue Indicates that you can safely remove the power supply module from the system.

Item	Indicator or Connector	Icon	Description
			<p>Off</p> <p>Indicates that you cannot remove the power supply module from the system.</p>
6	Service action required indicator		The service action required indicator lights amber when there is a fault in the power supply module.
7	AC power indicator		<p>Green</p> <p>Indicates that AC output voltage is within the limit.</p> <p>Off</p> <p>Indicates that AC output voltage is not within the limit.</p>

Physical-Disk LED Indicators

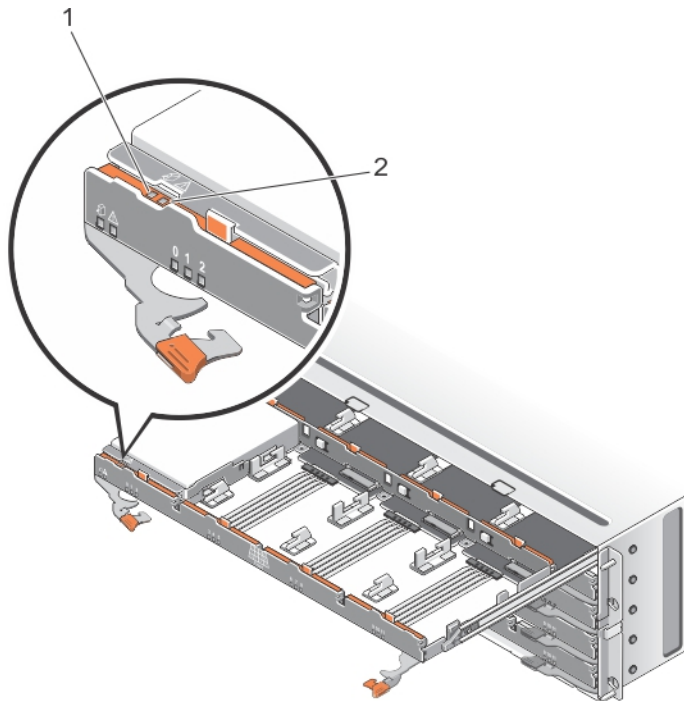





Figure 7. Physical-Disk LED Indicators

Item	Indicator	Icon	Description
1	Service action allowed indicator		<p> CAUTION: Remove the physical disk from the system only if the service action allowed indicator lights blue. Removing the physical disk from the system when the service action allowed indicator is off may damage the system.</p> <p>Blue Indicates that you can safely remove the physical disk from the system.</p> <p>Off Indicates that you cannot remove the physical disk from the system.</p>
2	Service action required indicator		The service action required indicator lights amber when there is a fault in the physical disk.

Controller Modules

RAID Controller Modules

RAID controller modules provide high-performance, advanced virtual disk configuration, and fault-tolerant disk subsystem management. Each RAID controller module contains 4 GB of mirrored cache for high availability and is protected by a battery powered cache offload mechanism.

 **NOTE:** 8 GB mirrored cache is an optional feature.

RAID controller modules provide the following data path and enclosure management functions:

- Monitoring and controlling enclosure environment elements (temperature, fans, power supplies, and enclosure LEDs)
- Controlling access to the physical disks
- Communicating enclosure attributes and states to the host server and management station

MD3860i iSCSI RAID Controller Module Features And Indicators

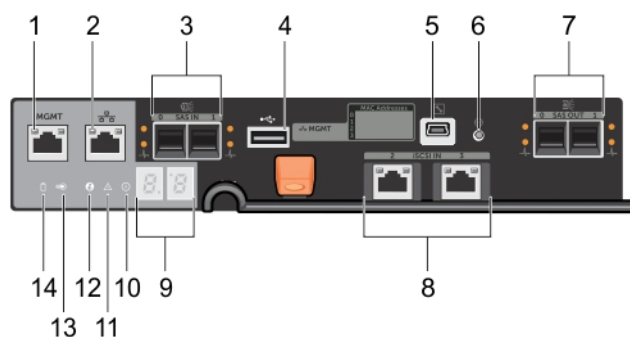









Figure 8. MD3860i iSCSI RAID Controller Module Features and Indicators

Item	Indicator, Button, or Connector	Icon	Description
1	Ethernet management port	MGMT	Provides a 100/1000 Mbps Ethernet connection for out-of-band management of the enclosure.
2	Reserved Ethernet port		Reserved port.

Item	Indicator, Button, or Connector	Icon	Description
3	12 Gbps SAS IN port (2)		Provides host-to-controller SAS connection.
4	USB port		Reserved port.
5	Mini USB port		Dell support only.
6	Password reset switch		Pressing this switch resets the password.
7	SAS expansion port (2)		Provides SAS OUT connection for cabling to a daisy chained expansion enclosure. Port 0 expansion port is recommended.
8	10 Gbps iSCSI IN port (2)		Provides host-to-controller iSCSI connection.
9	Seven segment display sequence		Displays status or error codes for the storage array.
10	System identification indicator		The system identification indicator blinks blue when system identification switch push-button on the enclosure front panel is pressed.
11	Controller fault indicator		The controller fault indicator lights amber when controller fault is detected.
12	Controller power indicator		The controller power indicator lights green when controller power is on.
13	Cache active or cache offload indicator		The cache active or cache offload indicator lights green when on-board controller memory contains data. If AC power fails, this LED changes to indicate cache offload status. If the password reset function has successfully changed the password, this LED flashes on and off briefly.
14	Battery fault indicator		The battery fault indicator lights amber when battery backup unit or battery has failed.

Expansion Controller Modules

Use the expansion controller modules to expand the storage capacity up to a maximum of 120 disks (180 disks with premium feature), by daisy-chaining your storage enclosure with up to two MD3060e expansion enclosures.

 **NOTE:** Hot-plug of MD3060e expansion enclosure is not supported.

MD3060e Expansion Module Features And Indicators

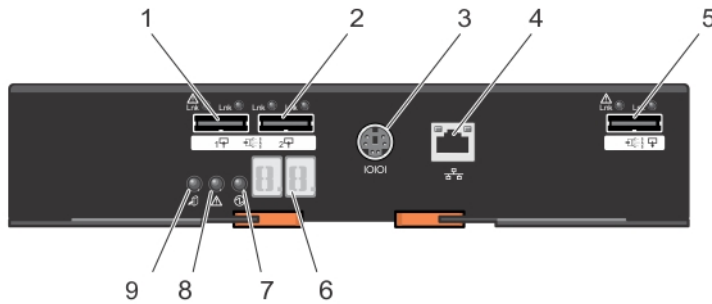







Figure 9. MD3060e Expansion Module Features and Indicators

Item	Indicator, Button, or Connector	Icon	Description
1	SAS IN port 0		Provides EMM to RAID controller SAS connection.
2	SAS IN port 1		Provides EMM to RAID controller SAS connection.
3	Serial debug port		Dell support only.
4	Telnet port		Dell support only.
5	SAS OUT port		Provides SAS connection for cabling to a downchain expansion enclosure.
6	Diagnostic LED		The numeric display consists of two seven-segment LEDs that provide information about enclosure identification and diagnostics.
7	Controller power indicator		The controller power indicator lights green when controller power is on.
8	Service action required indicator (system)		The service action required indicator lights amber when there is a fault in one of the components in the system.
9	Service action allowed indicator		<p>CAUTION: Remove the expansion module from the system only if the service action allowed indicator lights blue. Removing the expansion module from the system when the service action allowed indicator is off may damage the system.</p> <p>Blue Indicates that you can safely remove the expansion module from the system.</p> <p>Off Indicates that you cannot remove the expansion module from the system.</p>

RAID Controller Module—Additional Features

Battery Backup Unit

Each RAID controller module contains a two-cell Lithium ion nanopolymer battery backup unit (BBU). It provides power to the RAID controller module in the event of a power outage.

 **NOTE:** For virtual disks, the controller firmware changes the data cache setting based on the state of the battery. If the battery is missing or does not have sufficient charge, the controller flushes the cache and sets the **Write-Cache** attribute to **Write-Through** for all virtual disks. When the battery is replaced, **Write-Back** is re-enabled.

Storage Array Thermal Shutdown

The system automatically shuts down when system temperature exceeds the safe threshold. The battery backup unit protects against data loss by providing power to offload cache to non-volatile memory in the event of power loss.

Temperature threshold values determine the temperature at which shutdown occurs. These thresholds cannot be changed.

 **NOTE:** It is not necessary to shut down any expansion enclosures attached to the storage array when thermal shutdown occurs.

Table 1. Shutdown Threshold Type

Threshold Temperature Exceeding	Event Description
Nominal failure threshold	A critical event is set
Maximum failure threshold	Shutdown of the system power supplies occurs within 3 minutes
Shutdown threshold	Shutdown of the system power supplies occurs within 5 seconds

System Password Reset

To reset the password, push and hold down the password reset switch for at least five seconds. The password is deleted. You can change the password using MD Storage Manager.

For more information about setting your password, see the *Dell PowerVault MD Series Storage Arrays Administrator's Guide* at dell.com/powervaultmanuals.

 **NOTE:** If your system is iSCSI based, you can use the **Modular Disk Configuration Utility** to reset the system password.

 **NOTE:** The reset switch can be accessed by using a small object such as the tip of a pen.

Installing and removing system components

Recommended Tools

You may need the following items to perform the procedures in this section:

- #2 Phillips screwdriver
- T8 and T15 Torx screwdrivers
- Wrist grounding strap connected to ground

Removing And Installing The Front Bezel

Installing The Front Bezel

You must install the front bezel on the system to secure the disk drawers against accidental removal.

1. Align the slots on the back of the bezel with the guide pins on the front of the chassis.
2. Push the bezel toward the chassis until the bezel is seated properly and the release latches snap into place.

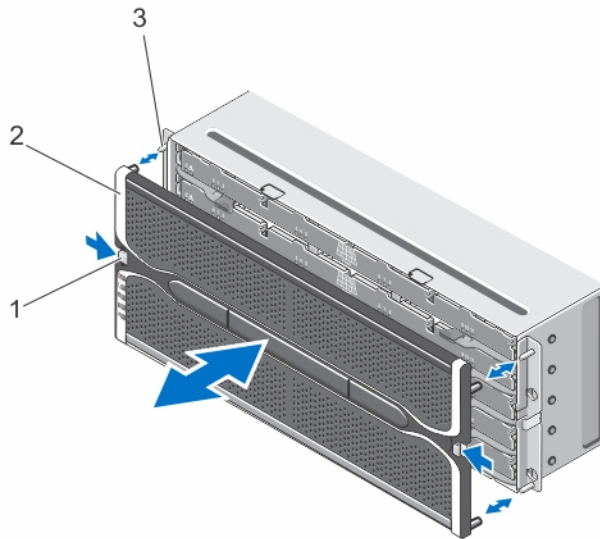

Figure 10. Removing and Installing the Front Bezel

1. release latches (2)
2. front bezel
3. guide pins (4)

Removing The Front Bezel

You must remove the front bezel to access the disk drawers, which enables you to remove and install physical disks in the system.

1. Press the release latch on either side of the front bezel.
2. Keeping the release latches pressed, hold the bezel and pull the bezel away from the system.

Service Action Allowed Indicator LED

Each hot-swappable component on your storage enclosure has a Service action allowed indicator. The Service action allowed indicator, indicates that a component can be safely removed from the storage enclosure.

CAUTION: Never remove any hot-swappable component until the Service action allowed indicator on the component lights blue. Removing a hot-swappable component with the Service action allowed indicator off, can result in a loss of data and data availability.

NOTE: The Service action allowed indicator LED is not used in server attached configurations.

Physical-Disk Drawers

Each storage array contains five physical-disk drawers. Each physical-disk drawer supports up to 12 hot-swappable physical disks.

NOTE: You can open only one physical-disk drawer at a time. If you attempt to open more than one drawer, it may cause unexpected results.

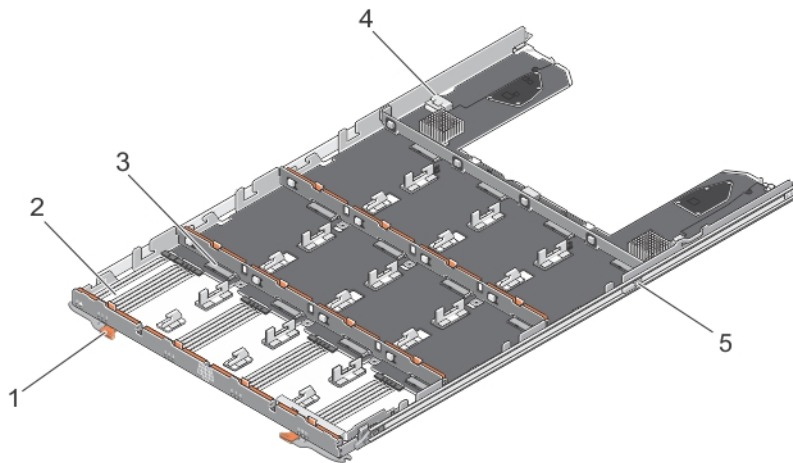

Figure 11. Inside the Physical-Disk Drawer

- | | |
|---|-----------------------------|
| 1. release latch (2) | 2. physical-disk bay (12) |
| 3. physical-disk connector (12) | 4. SAS cable connection (2) |
| 5. physical-disk drawer release tab (2) | |

Opening The Physical-Disk Drawer

⚠ CAUTION: Many repairs may only be done by a certified service technician. You should only perform troubleshooting and simple repairs as authorized in your product documentation, or as directed by the online or telephone service and support team. Damage due to servicing that is not authorized by Dell is not covered by your warranty. Read and follow the safety instructions that came with the product.

1. Remove the front bezel.
2. Hold and rotate the release latches away from the system until the physical-disk drawer is free from its slot.
3. Hold the physical-disk drawer and pull it away from the chassis.

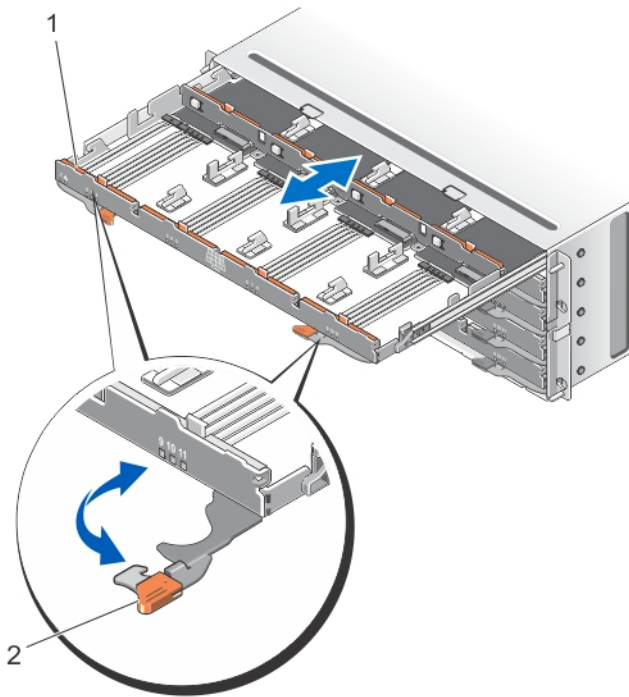

Figure 12. Opening and Closing the Physical-Disk Drawer

- 1. physical-disk drawer
- 2. release latch

Closing The Physical-Disk Drawer

CAUTION: Many repairs may only be done by a certified service technician. You should only perform troubleshooting and simple repairs as authorized in your product documentation, or as directed by the online or telephone service and support team. Damage due to servicing that is not authorized by Dell is not covered by your warranty. Read and follow the safety instructions that came with the product.

1. Hold the physical-disk drawer and push it into the chassis until it is seated properly.
2. Hold and rotate the release latches toward the system until the release latches lock into place.
3. Install the front bezel.

Removing The Physical-Disk Drawer

CAUTION: Many repairs may only be done by a certified service technician. You should only perform troubleshooting and simple repairs as authorized in your product documentation, or as directed by the online or telephone service and support team. Damage due to servicing that is not authorized by Dell is not covered by your warranty. Read and follow the safety instructions that came with the product.

1. Prepare the physical-disk drawer for removal using the **MD Storage Manager** software.

For more information, see the *Dell PowerVault MD Series Storage Arrays Administrator's Guide* at dell.com/powervaultmanuals.

2. Remove the front bezel.
3. Remove both the SAS cable chains from the back of the chassis.
4. Open the physical-disk drawer.

 **CAUTION:** Do not try to remove more than one drawer at a time. Ensure that you insert the drawer that is out completely before pulling out another drawer.

 **NOTE:** Note and save the location of the physical disks before removing the physical disks from the physical-disk drawer.

 **NOTE:** The physical-disk drawers are not hot-swappable. Replacing a physical-disk drawer causes all of the physical disks in the replaced drawer to be unavailable to the controllers in the storage subsystem. If the physical disks in array of the new physical-disk drawer were created without drawer loss protection, you must schedule down time to replace the drawer because these arrays fail when the drawer is replaced.

5. Remove all the physical disks from the disk drawer.
6. Slide the physical-disk drawer out until the release tab on each side of the disk drawer is visible.
7. Pull the release tab toward the front of the system to release the physical-disk drawer from the chassis and pull the physical-disk drawer out of the chassis.

6. Install the front bezel.
7. Using the MD Storage Manager, verify that the new physical-disk drawer is identified and operating correctly.

Physical Disks

Your system supports up to sixty 2.5 inch or 3.5 inch SAS and nearline SAS physical disks and 2.5 inch SAS SSDs per enclosure and up to a maximum 180 physical disks per storage array using premium features, by daisy chaining two additional MD3060e expansion enclosures.

Physical Disk Installation Guidelines

- To maintain proper airflow, install physicals disks from left to right and front to back in each drawer.
- A minimum of four disks must be installed in the front slots 0, 3, 6, and 9 of each drawer.
- The MD Series Dense storage array and expansion enclosure support mixing of physical disk types.

 **NOTE:** 15k RPM SAS drives are not supported. For the latest drive support, refer to *Dell PowerVault MD 34xx/38xx Series Support Matrix* at: dell.com/powervaultmanuals.

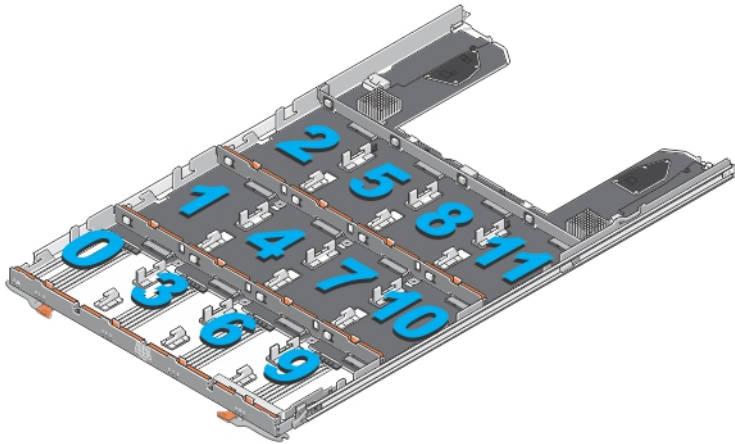



Figure 14. Slot Numbering on the Disk Drawer

Removing A Physical Disk From A Physical-Disk Carrier

 **CAUTION:** Many repairs may only be done by a certified service technician. You should only perform troubleshooting and simple repairs as authorized in your product documentation, or as directed by the online or telephone service and support team. Damage due to servicing that is not authorized by Dell is not covered by your warranty. Read and follow the safety instructions that came with the product.

1. Push out the edge on one side physical-disk carrier until the pins on the physical-disk carrier disengage from the holes on one side of the physical-disk.
2. Hold the physical disk and angle the physical disk out of the physical-disk carrier.

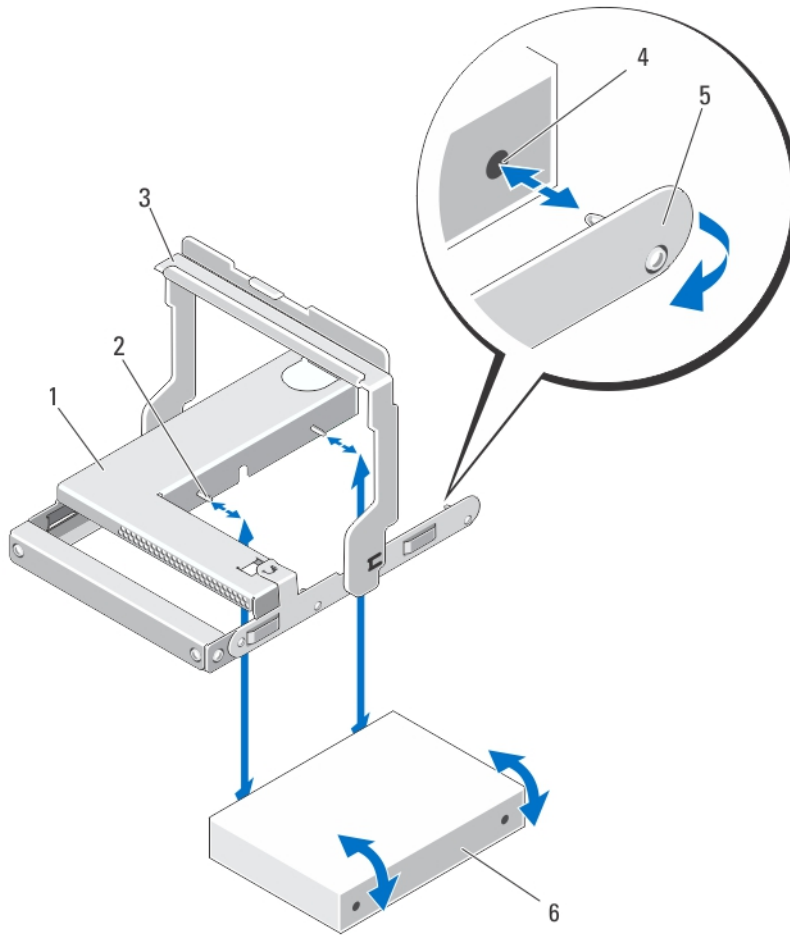

Figure 15. Removing and Installing the 2.5 Inch Physical Disk in a 2.5 Inch Physical-Disk Carrier

- | | |
|---------------------------------------|-------------------------------|
| 1. 2.5 inch physical drive cage | 2. guide pin (4) |
| 3. release handle | 4. holes on physical disk (4) |
| 5. carrier for 2.5 inch physical disk | 6. 2.5 inch physical disk |

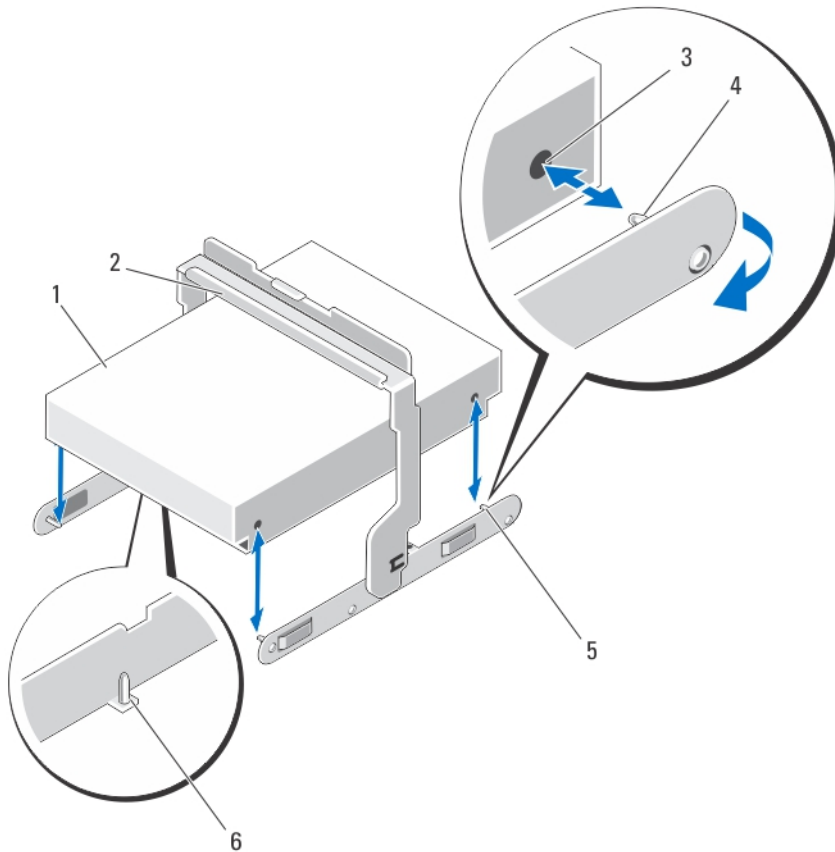

Figure 16. Removing and Installing the 3.5 Inch Physical Disk in a 3.5 Inch Physical-Disk Carrier

- | | |
|---------------------------------------|-------------------------|
| 1. 3.5 inch physical disk | 2. release handle |
| 3. holes on physical disk (4) | 4. side guide pin (4) |
| 5. carrier for 3.5 inch physical disk | 6. bottom guide pin (2) |

Installing A Physical Disk In A Physical-Disk Carrier

⚠ CAUTION: Many repairs may only be done by a certified service technician. You should only perform troubleshooting and simple repairs as authorized in your product documentation, or as directed by the online or telephone service and support team. Damage due to servicing that is not authorized by Dell is not covered by your warranty. Read and follow the safety instructions that came with the product.

1. Angle the physical disk into the physical-disk carrier.
2. Align the holes on one side (and if applicable, on the bottom) of the physical disk with the pins on the corresponding side of the physical-disk carrier.
3. Push out the edges on the other side of the physical-disk carrier, so that the holes on the other side of the physical disk align with the pins on the physical-disk carrier and snap the physical-disk carrier on to the physical disk.

Removing A Physical Disk From A Physical-Disk Drawer

△ CAUTION: Many repairs may only be done by a certified service technician. You should only perform troubleshooting and simple repairs as authorized in your product documentation, or as directed by the online or telephone service and support team. Damage due to servicing that is not authorized by Dell is not covered by your warranty. Read and follow the safety instructions that came with the product.

1. Remove the front bezel.
2. Identify the physical-disk drawer in which the faulty physical disk is installed.
3. Open the physical-disk drawer.
4. Identify and locate the faulty physical disk in the physical-disk drawer.

△ CAUTION: Remove the physical disk from the system only if the service action allowed indicator lights blue. Removing the physical disk from the system when the service action allowed indicator is off may damage the system.

🔩 NOTE: The **service action required** indicator lights blue on the:

- RAID controller module
 - physical-disk drawer
 - physical disk
5. Press the release tab to disengage the physical-disk carrier handle.
 6. Rotate the physical-disk carrier handle upward to disengage the physical disk from its connector.
 7. Hold the physical-disk carrier handle and lift the physical disk out and away from the system.

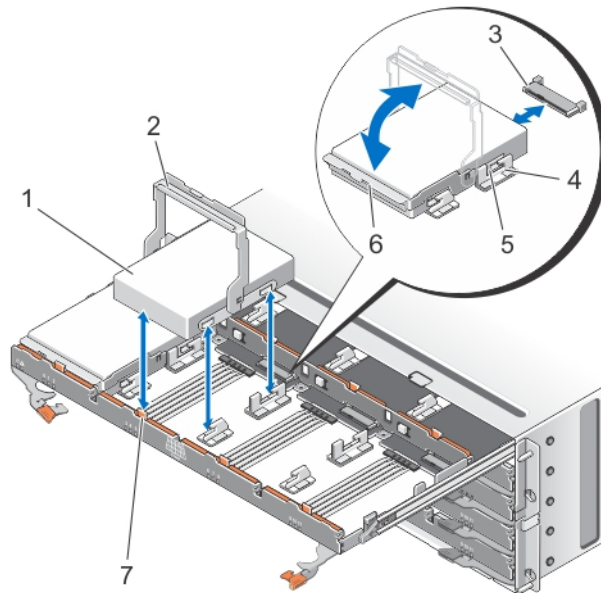

Figure 17. Removing and Installing the Physical Disk in the Physical-Disk Drawer

- | | |
|----------------------------|---------------------------------|
| 1. physical disk | 2. physical-disk carrier handle |
| 3. physical-disk connector | 4. notches (2) |
| 5. raised buttons (2) | 6. physical-disk carrier |

7. release tab (12)

Installing A Physical Disk In A Physical-Disk Drawer

CAUTION: Many repairs may only be done by a certified service technician. You should only perform troubleshooting and simple repairs as authorized in your product documentation, or as directed by the online or telephone service and support team. Damage due to servicing that is not authorized by Dell is not covered by your warranty. Read and follow the safety instructions that came with the product.

1. Rotate the physical-disk carrier handle upward to the vertical position.
2. Align the two raised buttons with the notches on the physical-disk drawer, lower the physical disk into the slot in the physical-disk drawer.

NOTE: Ensure that you install the physical disk from left to right and from front to back.

3. Rotate the handle downward until the physical disk is properly seated in the connector and the physical-disk carrier handle snaps into place.
4. Close the physical-disk drawer.
5. Install the front bezel.

SAS Chain Cables

There are two SAS cable chains on each side of the physical-disk drawer that connects the physical disks installed in the physical-disk drawer to the midplane.

- The connector on each SAS chain cable that connects to the physical-disk drawer is oriented horizontally.
- The connector on each SAS chain cable that connects to the midplane is oriented vertically.

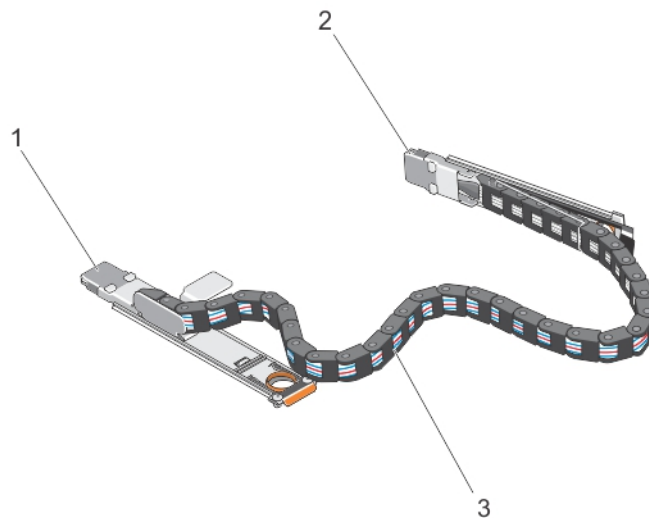

Figure 18. SAS Chain Cable Features

1. SAS cable connector on the physical-disk drawer (oriented horizontally)
2. SAS cable connector to the midplane (oriented vertically)

3. SAS chain cable (two per physical-disk drawer)

Removing The SAS Chain Cable(s)

△ CAUTION: Many repairs may only be done by a certified service technician. You should only perform troubleshooting and simple repairs as authorized in your product documentation, or as directed by the online or telephone service and support team. Damage due to servicing that is not authorized by Dell is not covered by your warranty. Read and follow the safety instructions that came with the product.

1. Remove the cooling fan module from one side on the back of the chassis.

△ CAUTION: If you are hot swapping the SAS cable chains, ensure that you complete the procedure on one side within ten minutes to avoid over heating of the storage enclosure.

△ CAUTION: Ensure that you are removing the SAS cable chain for the failed physical-disk drawer. Removing the SAS cable chain for the incorrect physical-disk drawer causes loss of data access and causes virtual disks to appear degraded in the MD Storage Manager.

2. Locate and identify the SAS chain cables for the failed physical-disk drawer.
3. To remove the chain cable mounting bracket from the midplane, insert your finger into the release tab (oriented vertically), and pull the mounting bracket completely out of the storage enclosure.
4. To remove the chain cable mounting bracket from the physical disk drawer, insert your finger into the release tab (oriented horizontally), and pull the mounting bracket completely out of the storage enclosure.
5. Install the cooling fan module.
6. Repeat the above mentioned steps for the SAS cable chain on the other side.

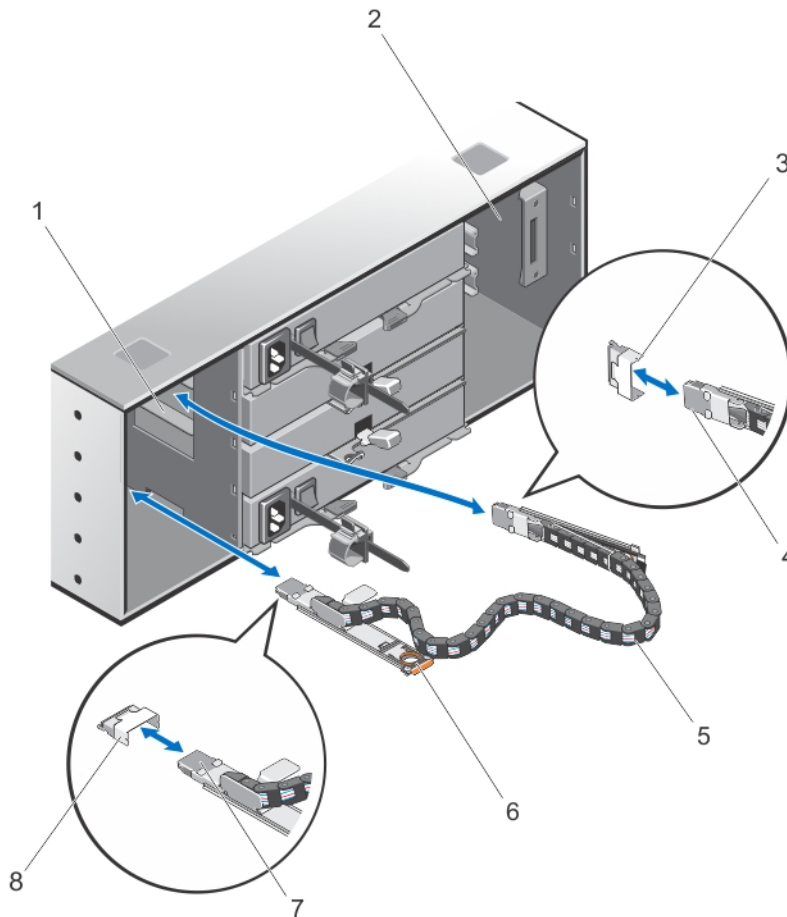

Figure 19. Removing and Installing the SAS Chain Cable(s)

- | | |
|--|--|
| 1. left cooling fan module bay | 2. right cooling fan module bay |
| 3. SAS cable connector on the midplane (two per physical disk drawer) | 4. SAS cable connector to the midplane (oriented vertically) |
| 5. SAS chain cable (two per physical disk drawer) | 6. release tab (oriented horizontally) |
| 7. SAS cable connector to the physical-disk drawer (oriented horizontally) | 8. SAS cable connector on the physical-disk drawer (oriented horizontally) |

Installing The SAS Chain Cable(s)

CAUTION: Many repairs may only be done by a certified service technician. You should only perform troubleshooting and simple repairs as authorized in your product documentation, or as directed by the online or telephone service and support team. Damage due to servicing that is not authorized by Dell is not covered by your warranty. Read and follow the safety instructions that came with the product.

1. Remove the cooling fan module from one side on the back of the chassis.

 **CAUTION: If you are hot swapping the SAS cable chains, ensure that you complete the procedure on one side within ten minutes to avoid over heating of the storage enclosure.**



2. Locate and identify the SAS chain cables for the new physical-disk drawer.
3. Connect the chain cable mounting bracket (oriented horizontally) to the physical-disk drawer.
4. Connect the chain cable mounting bracket (oriented vertically) to the midplane.
5. Install the cooling fan module.
6. Repeat the above mentioned steps for the SAS cable chain on the other side.

RAID Controller Modules

Removing A RAID Controller Module Or Expansion Module

 **CAUTION: Many repairs may only be done by a certified service technician. You should only perform troubleshooting and simple repairs as authorized in your product documentation, or as directed by the online or telephone service and support team. Damage due to servicing that is not authorized by Dell is not covered by your warranty. Read and follow the safety instructions that came with the product.**

 **CAUTION: To avoid damage to the sensitive EMI contacts on the RAID controller module or expansion module, do not stack RAID controller modules.**

1. Using MD Storage Manager, save the RAID controller module or expansion module profile.
2. Identify and locate the RAID controller module or expansion module that you want to replace.
 -  **NOTE:** The **controller fault** indicator lights amber when controller fault is detected.
 -  **NOTE:** Label each cable and SFP+ module to ensure that all cables or SFP+ modules are properly connected to the new RAID controller module or expansion module. You must install the SFP+ modules in the same slots on the new RAID controller module or expansion module.
3. Disconnect the cables connected to the RAID controller module or expansion module.
4. Push down on the release tab and pull the release lever away from the chassis.
5. Hold the release lever and pull the module away from the chassis.

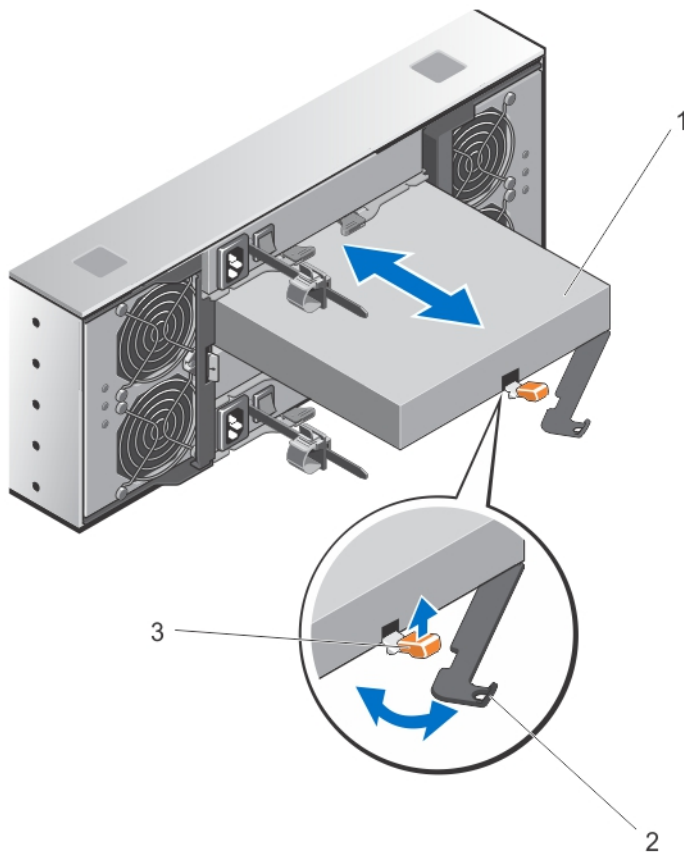

Figure 20. Removing and Installing a RAID Controller Module or Expansion Module

- | | |
|---|------------------|
| 1. RAID controller module or expansion module | 2. release lever |
| 3. release tab | |

Installing A RAID Controller Module Or Expansion Module

⚠ CAUTION: Many repairs may only be done by a certified service technician. You should only perform troubleshooting and simple repairs as authorized in your product documentation, or as directed by the online or telephone service and support team. Damage due to servicing that is not authorized by Dell is not covered by your warranty. Read and follow the safety instructions that came with the product.

1. Insert the RAID controller module or expansion module into the bay until it seats into place.
2. Push the release lever toward the chassis until it clicks into place.
3. Connect all the cables and SFP+ modules to the RAID controller module or expansion module.
4. Using the MDSM, verify that the new RAID controller module or expansion module is identified.
5. If applicable, update the firmware for the RAID controller module or expansion module.

For information about the latest firmware, see dell.com/support.

Opening The RAID Controller Module

△ CAUTION: Many repairs may only be done by a certified service technician. You should only perform troubleshooting and simple repairs as authorized in your product documentation, or as directed by the online or telephone service and support team. Damage due to servicing that is not authorized by Dell is not covered by your warranty. Read and follow the safety instructions that came with the product.

1. Remove the RAID controller module from the chassis.
2. Remove the screws from the sides of the RAID controller module.
3. While pressing the indent, slide the cover in the direction of the arrow and lift it away from the RAID controller module.

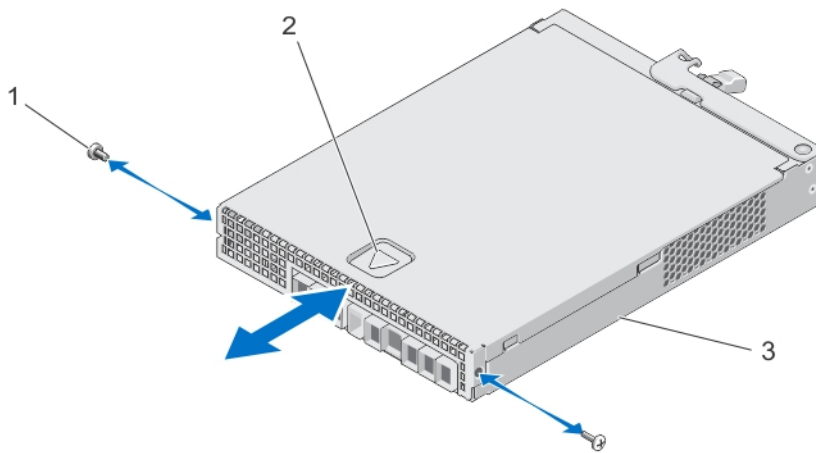

Figure 21. Opening and Closing the RAID Controller Module

- | | |
|---------------------------|-----------|
| 1. screw (2) | 2. indent |
| 3. RAID controller module | |

Closing The RAID Controller Module

△ CAUTION: Many repairs may only be done by a certified service technician. You should only perform troubleshooting and simple repairs as authorized in your product documentation, or as directed by the online or telephone service and support team. Damage due to servicing that is not authorized by Dell is not covered by your warranty. Read and follow the safety instructions that came with the product.

1. Place the cover onto the RAID controller module and offset it slightly towards the back, so that the hooks on the cover fit over the corresponding slots on the RAID controller module.
2. Slide the cover toward the front till it snaps into place.
3. Replace the screws on the RAID controller module.
4. Install the RAID controller module in the chassis.

RAID Controller Module Backup Battery Unit

The battery backup unit provides backup power to the RAID controllers in case of power failure. It ensures power backup for at least 30 minutes to facilitate moving of memory stored in the controller cache to persistent storage.

Removing The RAID Controller Module Backup Battery Unit

You must replace a faulty battery backup unit immediately to ensure availability of backup power in case of power failure.

CAUTION: Many repairs may only be done by a certified service technician. You should only perform troubleshooting and simple repairs as authorized in your product documentation, or as directed by the online or telephone service and support team. Damage due to servicing that is not authorized by Dell is not covered by your warranty. Read and follow the safety instructions that came with the product.

1. Identify and locate the controller for which the battery backup unit has failed.
NOTE: The battery fault indicator for the affected controller lights amber.
2. Take the affected controller offline.
3. Disconnect all the cables connected to the array.
4. Remove the RAID controller module.
5. Open the RAID controller module.
6. Loosen the screw that secures the backup battery unit to the RAID controller module.
7. Slide the backup battery unit in the direction of the arrow and lift it out of the RAID controller module.

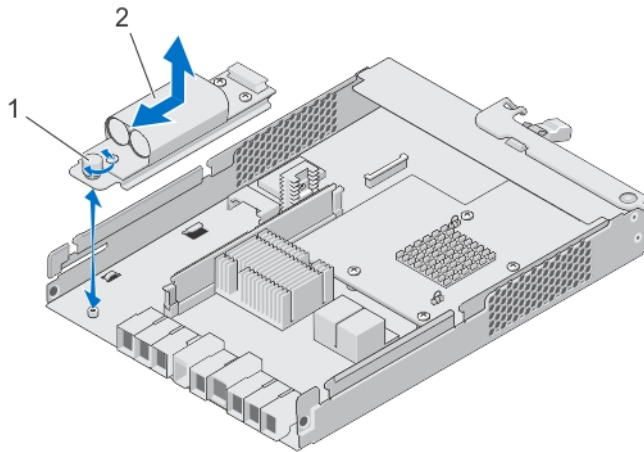



Figure 22. Removing and Installing the RAID Controller Module Backup Battery Unit

1. screw

2. backup battery unit

Installing The RAID Controller Module Backup Battery Unit

You must replace the RAID controller battery backup unit immediately to ensure the security of the data in the controller cache memory.

 **CAUTION: Many repairs may only be done by a certified service technician. You should only perform troubleshooting and simple repairs as authorized in your product documentation, or as directed by the online or telephone service and support team. Damage due to servicing that is not authorized by Dell is not covered by your warranty. Read and follow the safety instructions that came with the product.**

1. Align the backup battery unit with the slots on the RAID controller module.
2. Slide the backup battery unit toward the connector on the RAID controller module.
3. Tighten the screw that secures the backup battery unit to the RAID controller module.
4. Close the RAID controller module.
5. Install the RAID controller module.
6. Connect all the cables to the RAID controller and the storage array.
7. Use MD Storage Manager to check the status of all the storage arrays.

Power Supplies

Your system supports two hot-swappable 1755 W power supply modules.

When two identical power supplies are installed, the power supply configuration is redundant. In redundant mode, power is supplied to the system equally from both power supplies to maximize efficiency.

When one power supply module is removed or has failed, the power supply configuration is non-redundant. Power is supplied to the system only by the single power supply module.

 **CAUTION: Do not plug the enclosure into a standard power outlet. Your storage array is shipped with two IEC C19 to C20 jumper cables. Connect the C19 plug to the array's power supplies and the C20 plug to the power distribution unit (PDU) in the rack cabinet. For power redundancy, split the power connections from each enclosure into separate PDUs and connect the PDUs to external power receptacles on different circuits. The enclosure supports only 200 V to 240 V input sources.**

Removing A Power Supply Module

 **CAUTION: Many repairs may only be done by a certified service technician. You should only perform troubleshooting and simple repairs as authorized in your product documentation, or as directed by the online or telephone service and support team. Damage due to servicing that is not authorized by Dell is not covered by your warranty. Read and follow the safety instructions that came with the product.**

 **CAUTION: The system requires one power supply module for normal operation. Remove and replace only one power supply at a time in a system that is powered on.**

1. Identify and locate the faulty power supply module.

 **NOTE:** The **Service action required** indicator lights amber when there is a fault in the power supply module.

2. Disconnect the power cable from the power source and the power supply module you intend to remove and remove the cables from the cable securing strap.
3. Pull and rotate the two release levers away from the chassis until the power supply module is free from the slot.
4. Hold the power supply module and slide the power supply out of the chassis.

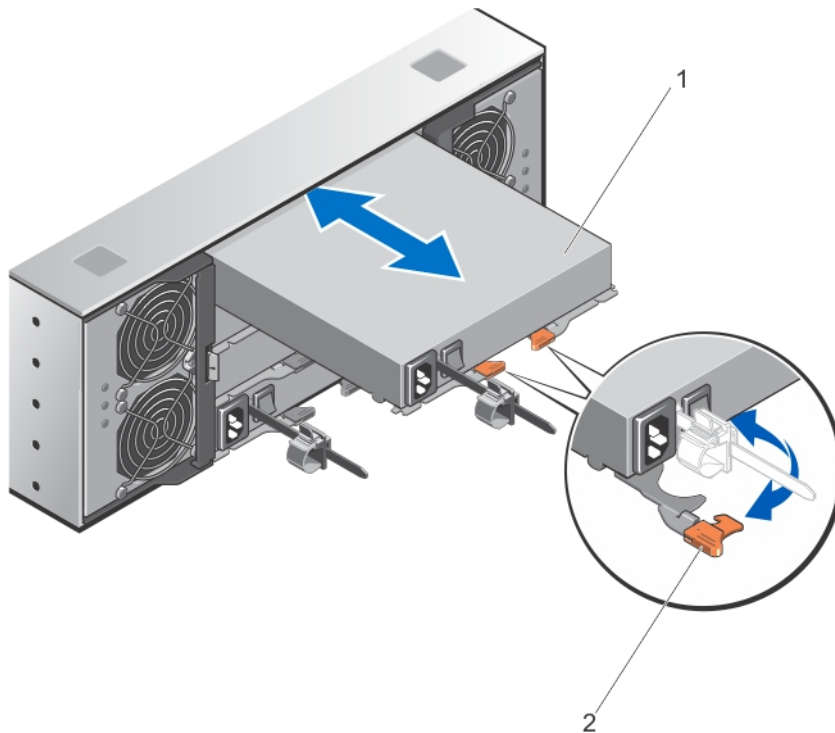



Figure 23. Removing and Installing the power supply module

1. power supply

2. release latch (2)

Installing A Power Supply Module

 **CAUTION:** Many repairs may only be done by a certified service technician. You should only perform troubleshooting and simple repairs as authorized in your product documentation, or as directed by the online or telephone service and support team. Damage due to servicing that is not authorized by Dell is not covered by your warranty. Read and follow the safety instructions that came with the product.

Ensure that the power switch on the power supply module that you are installing, is in the **off** position.

1. Slide the new power supply module into the chassis until the power supply module is fully seated.
2. Rotate both the release lever toward the chassis until the power supply module locks into place.
3. Connect the power cable to the power supply module and plug the cable into a power outlet.

 **CAUTION:** When connecting the power cable, secure the cable with the cable securing bracket.

 **NOTE:** When installing or hot-swapping a new power supply module, allow several seconds for the system to recognize the power supply module and determine its status. The power-supply status indicator turns green to signify that the power supply module is functioning properly.

Cooling Fan Modules

Your system supports two hot-swappable cooling fan modules.

Removing A Cooling Fan Module

 **CAUTION:** Many repairs may only be done by a certified service technician. You should only perform troubleshooting and simple repairs as authorized in your product documentation, or as directed by the online or telephone service and support team. Damage due to servicing that is not authorized by Dell is not covered by your warranty. Read and follow the safety instructions that came with the product.

 **CAUTION:** The cooling fans are hot-swappable. To maintain proper cooling while the system is on, replace only one fan at a time.

 **NOTE:** The procedure for removing each cooling fan module is identical.

Make sure that the **Service action allowed** indicator lights blue before you remove the cooling fan module. For more information, see [Cooling Fan Module LED Indicator Codes](#).

 **NOTE:** The Service action allowed indicator LED is not used in server attached configurations.

1. Identify and locate the failed cooling fan module.

 **CAUTION:** Remove the cooling fan module from the system only if the Service action allowed indicator lights blue. Removing the cooling fan module from the system when the Service action allowed indicator is off may damage the system.

 **NOTE:** The Service action allowed indicator LED is not used in server attached configurations.

2. Press the cooling fan module release latch to release the cooling fan module handle.
3. Rotate the cooling fan module handle away from the system, until the cooling fan module is released from the slot.
4. Holding the cooling fan module release handle, pull the cooling fan module away from the chassis.

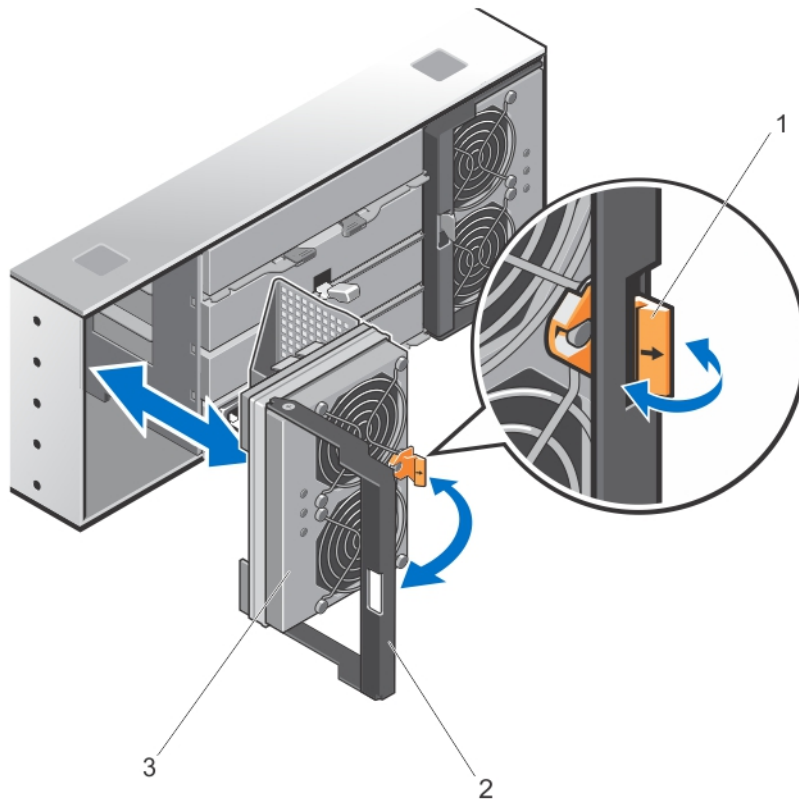

Figure 24. Removing and Installing the Cooling Fan Module

1. cooling fan module release latch
2. cooling fan module handle
3. cooling fan module

Installing A Cooling Fan Module

⚠ CAUTION: Many repairs may only be done by a certified service technician. You should only perform troubleshooting and simple repairs as authorized in your product documentation, or as directed by the online or telephone service and support team. Damage due to servicing that is not authorized by Dell is not covered by your warranty. Read and follow the safety instructions that came with the product.

1. Align the cooling fan module with the slot on the back of the chassis.
2. Slide the cooling fan module into the slot until it is properly seated.
3. Rotate the cooling fan module handle toward the chassis until the cooling fan module handle locks in place.

⚠ CAUTION: For proper cooling of the storage array, ensure that all the cooling fans are operational at all times.

Troubleshooting your system

Safety first—for you and your system

 **CAUTION:** Many repairs may only be done by a certified service technician. You should only perform troubleshooting and simple repairs as authorized in your product documentation, or as directed by the online or telephone service and support team. Damage due to servicing that is not authorized by Dell is not covered by your warranty. Read and follow the safety instructions that came with the product.

Troubleshooting Storage Array Startup Failure

 **NOTE:** If you need to replace a RAID controller, always hot plug the replacement controller when the array is powered on. All new hard drives should be hot plugged to the array. Do not use drives or RAID controller from another (foreign) array.

If your system halts during startup, check if:

- The array emits a series of beeps.
 - The array fault LEDs are lit.
 - There is a constant scraping or grinding sound when you access the physical disk.
- For assistance, contact Dell Support.

Troubleshooting Loss Of Communication

For information about troubleshooting loss of communication, see [Troubleshooting Array And Expansion Enclosure Connections](#).

Troubleshooting External Connections

- Verify that the cables are connected to the correct ports before troubleshooting any external devices. For the location of the back-panel connectors on your storage array, see the Back-panel features section in this document.
- Ensure that all the cables are securely attached to the external connectors on your array.
- For information on cabling, see the Deployment Guide for your storage array at dell.com/support/manuals.

Troubleshooting Power Supply Modules

 **CAUTION:** Many repairs may only be done by a certified service technician. You should only perform troubleshooting and simple repairs as authorized in your product documentation, or as directed by the online or telephone service and support team. Damage due to servicing that is not authorized by Dell is not covered by your warranty. Read and follow the safety instructions that came with the product.

 **CAUTION:** It is recommended that you turn off the host server before turning off the array to prevent loss of data.

1. Locate the faulty power supply and determine the status of the LEDs.
 - If the AC power LED is not lit, check the power cord and power source into which the power supply module is plugged.
 - Connect another device to the power source to verify if it is working.
 - Connect the cable to a different power source.
 - Replace the power cable. If the problem is not resolved, see [Getting Help](#).
 - If the DC power LED is not lit, verify that the power switch is turned on. If the power switch is turned on, see step 2.
 - If the power supply module's fault indicator is lit, see [Getting Help](#).

 **CAUTION:** Power supply modules are hot-swappable. The array can operate on a single power supply module; however both modules must be installed to ensure proper cooling. A single power supply module can be removed from a powered-on array for a maximum period of five minutes. Beyond that time, the array may automatically shut down to prevent damage.

2. Reseat the power supply module by removing and reinstalling it.

 **NOTE:** After installing a power supply module, allow several seconds for the array to recognize the power supply module and to determine if it is working properly.

If the problem is not resolved, see [Getting Help](#).

Troubleshooting Array Cooling Problems

 **CAUTION:** Many repairs may only be done by a certified service technician. You should only perform troubleshooting and simple repairs as authorized in your product documentation, or as directed by the online or telephone service and support team. Damage due to servicing that is not authorized by Dell is not covered by your warranty. Read and follow the safety instructions that came with the product.

Ensure that none of the following conditions exist:

- Ambient temperature is too high, as a physical-disk drawer is left open for an extended period.
- External airflow is obstructed.
- The cooling fan module is removed or has failed.

If the problem is not resolved, see [Getting Help](#).

Troubleshooting Expansion Enclosure Management Modules

 **CAUTION:** Many repairs may only be done by a certified service technician. You should only perform troubleshooting and simple repairs as authorized in your product documentation, or as directed by the online or telephone service and support team. Damage due to servicing that is not authorized by Dell is not covered by your warranty. Read and follow the safety instructions that came with the product.

 **CAUTION:** It is recommended that you turn off the host server before turning off the expansion enclosure array to prevent loss of data.

If EMM status LED is blinking amber (5 times per sequence), update the firmware to the latest supported firmware on both the EMMs. For more information on updating your EMM firmware, see **Management Firmware Downloads** in the *Dell PowerVault MD Series Storage Arrays Administrator's Guide* at dell.com/powervaultmanuals.

If The EMM Status LED Is Solid Or Blinking Amber (2 Or 4 Times Per Sequence)

1. Turn off the host server.
2. Remove the EMM and verify that the pins on the backplane and EMM are not bent.
3. Reseat the EMM module and wait for 30 seconds.
4. Turn on the host server.
5. Check the EMM status LED.
6. If the LED does not turn Green, replace the EMM.

If the problem is not resolved, see [Getting Help](#).

If The Link Status LEDs Are Not Green

1. Turn off the host server.
2. Reseat the cables on the expansion array and the server.
3. Turn on the expansion arrays and then the storage array and wait until the system is fully booted.
4. Turn on the host server.
5. Check the link status LED. If the link status LED is not green, replace the cables.

If the problem is not resolved, see [Getting Help](#).

Troubleshooting Physical Disks

 **CAUTION:** Many repairs may only be done by a certified service technician. You should only perform troubleshooting and simple repairs as authorized in your product documentation, or as directed by the online or telephone service and support team. Damage due to servicing that is not authorized by Dell is not covered by your warranty. Read and follow the safety instructions that came with the product.

1. Check the storage array profile to ensure that the most current version of the firmware is installed. For more information, see the Support Matrix at dell.com/support/manuals.
2. Remove the physical disk from the system.

 **NOTE:** You must ensure that you check the physical disk indicators before removing the faulty physical disk from the system.

3. Check the physical disks and the midplane to ensure that the connectors are not damaged.
4. Reinstall the physical disk.
5. If the problem is not resolved, replace the failed physical disk.
If the problem persists, see [Getting Help](#).

Troubleshooting Array And Expansion Enclosure Connections

1. Verify the following:
 - the SAS OUT status LED is green
 - for each FC IN port connected to a cable, at least one of the paired LEDs is on
2. Ensure that all the cables are attached correctly according to the array mode you selected.
3. Turn off the host server, storage array, and expansion enclosures.
4. Reseat the RAID controller module and reconnect cables on the storage array and the host server.
5. Turn on the expansion arrays and then the storage array and wait until the system is fully booted.
6. Turn on the host server.
7. Check the LEDs of all cabled ports. Replace the fibre optic cables of any port(s) where both LEDs are unlit.

If the problem is not resolved, see [Getting Help](#).

 **NOTE:** You must turn off the host server before resetting the cables on the storage array or expansion enclosure.

8. Reboot the host server.

Troubleshooting A Wet Storage Array

 **CAUTION:** Many repairs may only be done by a certified service technician. You should only perform troubleshooting and simple repairs as authorized in your product documentation, or as directed by the online or telephone service and support team. Damage due to servicing that is not authorized by Dell is not covered by your warranty. Read and follow the safety instructions that came with the product.

1. Turn off the array and disconnect all the cables.
2. Remove the following components from the array:
 - Physical disks
 - RAID controller modules
 - Power supply modules
 - Cooling fan modules
3. Let the system dry thoroughly for at least 24 hours.
4. Reinstall the components you removed in step 2.
5. Connect all the cables and turn on the array.

Troubleshooting A Damaged Array

 **CAUTION:** Many repairs may only be done by a certified service technician. You should only perform troubleshooting and simple repairs as authorized in your product documentation, or as directed by the online or telephone service and support team. Damage due to servicing that is not authorized by Dell is not covered by your warranty. Read and follow the safety instructions that came with the product.

1. Ensure that the following components are properly installed:
 - Physical disks
 - RAID controller modules
 - Power supply modules
 - Cooling fan module
2. Ensure that all the cables are properly connected and that there are no damaged pins in the connectors.
3. Run the diagnostics available in **Dell PowerVault Modular Disk (MD) Storage Manager**.
4. In the **AMW**, select a component in the **Hardware** pane of the **Hardware** tab.
5. Select **Hardware** → **RAID Controller Module** → **Advanced** → **Run Diagnostics** → **RAID Controller Module**.

Controller Failure Conditions

Certain events can cause a RAID controller module to fail and/or shut down. Unrecoverable ECC memory or PCI errors, or critical physical conditions can cause lockdown. If your RAID storage array is configured for redundant access and cache mirroring, the surviving controller can normally recover without data loss or shutdown.

Critical Conditions

The storage array generates a critical event if the RAID controller module detects a critical condition that could cause immediate failure of the array and/or loss of data. The storage array is in a critical condition if one of the following occurs:

- More than one fan has failed
- Any midplane temperature sensors in the critical range
- Midplane/power supply module failure
- Two or more temperature sensors are unreadable
- Failure to detect or unable to communicate with peer port

 **NOTE:** If both RAID controller modules fail simultaneously, the enclosure cannot issue critical or noncritical event alarms for any enclosure component.

Noncritical Conditions

A noncritical condition is an event or status that does not cause immediate failure, but must be corrected to ensure continued reliability of the storage array. Examples of noncritical events include the following:

- One power supply module has failed
- One cooling fan module has failed
- One RAID controller module in a redundant configuration has failed
- A battery has failed or has been removed
- A physical disk in a redundant virtual disk has failed

Invalid Storage Array

The RAID controller module is supported only in a Dell-supported storage array. After installation in the storage array, the controller performs a set of validation checks. The array status LED is lit with a steady amber color while the RAID controller module completes these initial tests and the controllers are booted successfully. If the RAID controller module detects a non-Dell supported storage array, the controller does not startup. The RAID controller module does not generate any events to alert you in the event of an invalid array, but the array status LED is lit with a flashing amber color to indicate a fault state.

ECC Errors



RAID controller firmware can detect ECC errors and can recover from a single-bit ECC error whether the RAID controller module is in a redundant or nonredundant configuration. A storage array with redundant controllers can recover from multi-bit ECC errors as well because the peer RAID controller module can take over, if necessary.

The RAID controller module fails over if it experiences up to 10 single-bit errors, or up to three multi-bit errors.



PCI Errors

The storage array firmware can detect and only recover from PCI errors when the RAID controller modules are configured for redundancy. If a virtual disk uses cache mirroring, it fails over to its peer RAID controller module, which initiates a flush of the dirty cache.

Technical Specifications



Physical Disks	
Physical disks	Up to sixty 3.5 inch or 2.5 inch SAS or nearline SAS physical disks or 2.5 inch SAS SSDs
RAID Controller Modules	
RAID controller modules	Two hot-swappable modules with temperature sensors 4 GB or 8 GB of cache per controller
Dell PowerVault MD3860i storage arrays	Provides host-to-controller 10 Gbps iSCSI connection and two 12 Gbps SAS connections
Expansion Modules	
Dell PowerVault MD3060e expansion enclosures	Supports 120 physical disks, in addition to 60 physical disks in the RAID enclosure Redundant path connectivity provides redundant data paths to each hard drive  NOTE: Support for 180 physical disks is a premium feature and requires activation. The maximum number of physical disks supported without using the premium feature is 120.
SAS connectors	Two SAS IN ports to connect hosts One SAS OUT port for expansion to an additional PowerVault MD3060e expansion enclosure  NOTE: SAS connectors are SFF-80644 compliant.
Serial connector (debug port)	Six pin port  NOTE: For technical support use only.
Back-Panel Connectors (Per RAID Controller Module)	
SAS connectors	Two SAS IN ports to connect hosts

Back-Panel Connectors (Per RAID Controller Module)

	 NOTE: SAS and iSCSI connections to the same host is not supported.
	Two SAS OUT ports, it is recommended that you use the first port for expansion to an additional PowerVault MD3060e expansion enclosure. Only one expansion port is supported at any given time.
	 NOTE: SAS connectors are SFF-8644 compliant.
Serial connector (debug port)	One 6-pin mini serial port
	 NOTE: For technical support use only.
Management Ethernet connector	One 100/1000 Mbps Ethernet connection for out-of-band management of the enclosure and the second Ethernet port is reserved.
iSCSI connectors	Two 10 Gbps iSCSI IN connectors to connect hosts

Power

AC power supply (per power supply)

Wattage	1755 W
Heat dissipation (maximum)	5988 BTU/hr
 NOTE: Heat dissipation is calculated using the power supply wattage rating. The heat dissipation values are for the entire system which includes chassis and two controllers.	
Voltage	220 V AC, autoranging, 50 Hz/60 Hz
 NOTE: This system is also designed to be connected to IT power systems with a phase to phase voltage not exceeding 230 V.	

Battery	6.6 V DC, 1100 mAh, 7.26 W Lithium ion battery
---------	--

Environmental

 **NOTE:** For additional information about environmental measurements for specific system configurations, see dell.com/environmental_datasheets.

Temperature

Environmental

Operating Continuous operation: 10 °C to 35 °C (50 °F to 95 °F) at 20% to 80% relative humidity (RH), with 26 °C maximum dew point. De-rate maximum allowable dry bulb temperature at 1 °C/300 m (1 °F per 550 ft) above 900 m (2952.75 ft).

 **NOTE:** For information on supported expanded operating temperature range and configurations, see the Owner's Manual at dell.com/support/manuals.

Storage –40 °C to 65 °C (–40 °F to 149 °F) with a maximum temperature gradation of 20 °C per hour

Relative humidity

Operating 20% to 80% (noncondensing) with maximum humidity gradation of 10% per hour

Storage 5% to 95% at a maximum wet bulb temperature of 38 °C (100.4 °F)

Maximum vibration

Operating 0.26 G_{rms} at 5 Hz to 350 Hz in operational orientation

Storage 1.88 G_{rms} at 10 Hz to 500 Hz for 15 minutes (all six sides tested)

Maximum shock

Operating One shock pulse in the positive z axis of the system at 31 G for 2.6 ms in the operational orientation

Storage Six consecutively executed shock pulses in the positive and negative x, y, and z axes (one pulse on each side of the system) at 71 G for up to 2 ms
Six consecutively executed shock pulses in the positive and negative x, y, and z axes (one pulse on each side of the system) of 22 G faired square wave pulse with velocity change at 200 inches/second (508 centimeters/second)

Altitude

Operating Maximum 3000 m (9,842 ft)

Storage Maximum 12192 m (40,000 ft)

Airborne contaminant level

Class G1 as defined by ISA-S71.04-1985

Getting help

Locating your system service tag

Your system is identified by a unique Express Service Code and Service Tag number. The Express Service Code and Service Tag are found on the front of a physical DR Series system by pulling out the information tag. This can also be found on the support tab in the GUI. This information is used by Dell to route support calls to the appropriate personnel.

Contacting Dell

Dell provides several online and telephone-based support and service options. If you do not have an active Internet connection, you can find contact information on your purchase invoice, packing slip, bill, or Dell product catalog. Availability varies by country and product, and some services may not be available in your area. To contact Dell for sales, technical support, or customer-service issues:

1. Go to **dell.com/support**.
2. Select your country from the drop-down menu on the bottom right corner of the page.
3. For customized support:
 - a. Enter your system Service Tag in the **Enter your Service Tag** field.
 - b. Click **Submit**.

The support page that lists the various support categories is displayed.
4. For general support:
 - a. Select your product category.
 - b. Select your product segment.
 - c. Select your product.

The support page that lists the various support categories is displayed.

Documentation feedback

If you have feedback for this document, write to **documentation_feedback@dell.com**. Alternatively, you can click on the **Feedback** link in any of the Dell documentation pages, fill out the form, and click **Submit** to send your feedback.